

TFT LCD模组基本结构简介

BenQ

英文缩写

TFT---- 薄膜工艺学
Thin Film Technology

LCD---- 液晶显示器
Liquid Crystal Display

LCD模组构造图

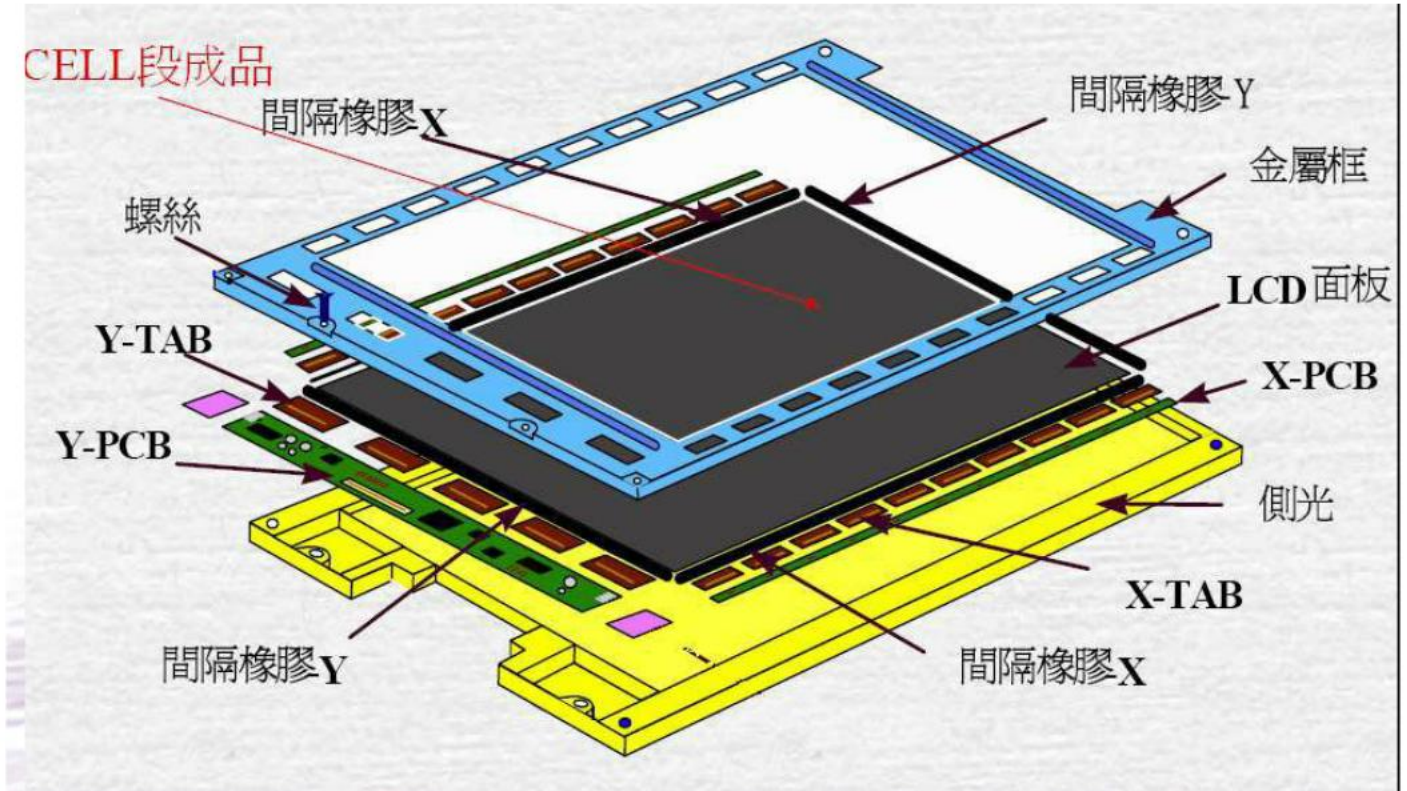

LCD面板构造图

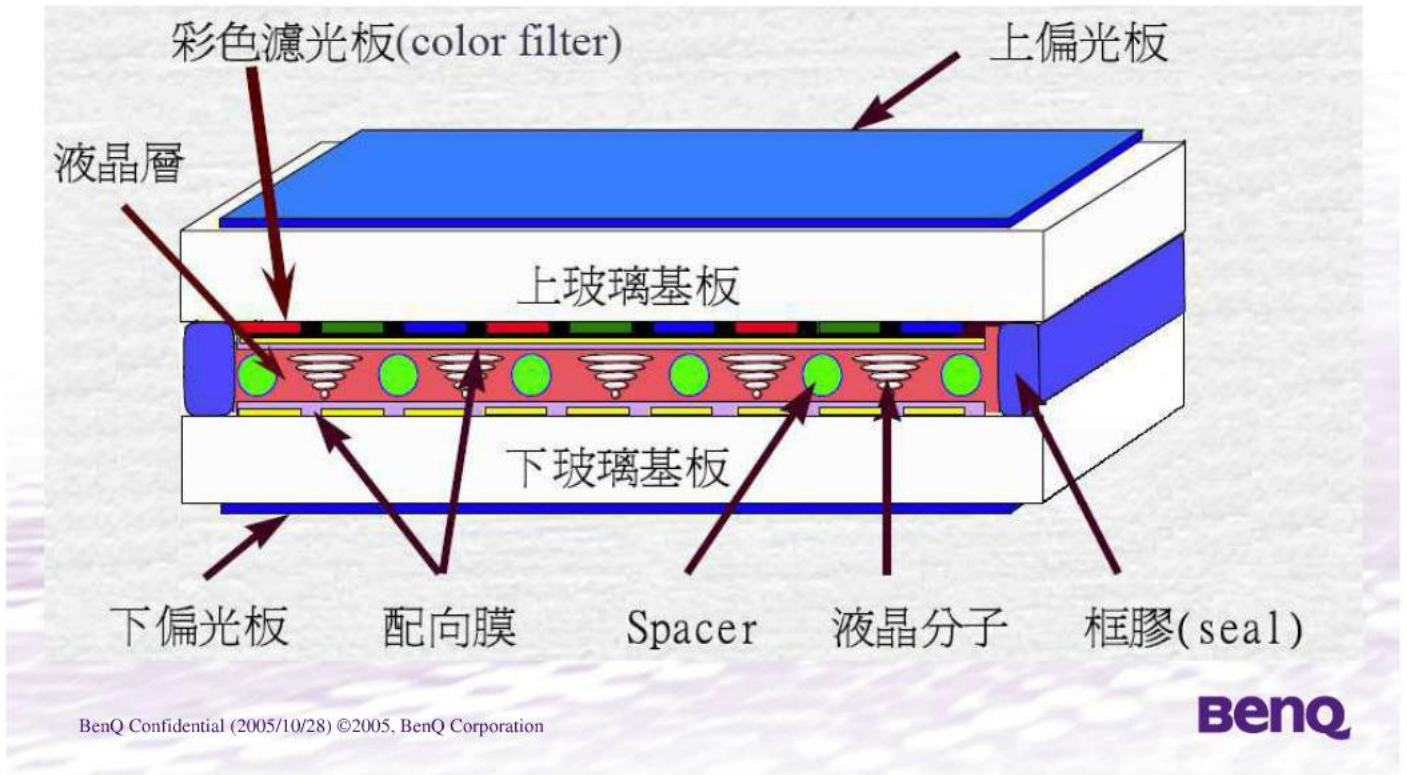

Spacer的目的

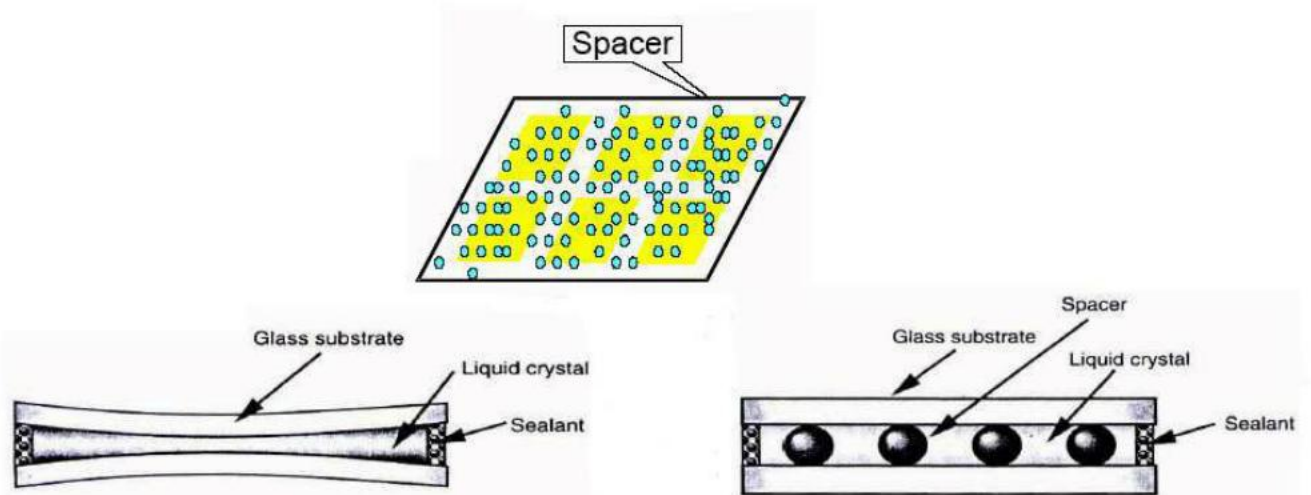

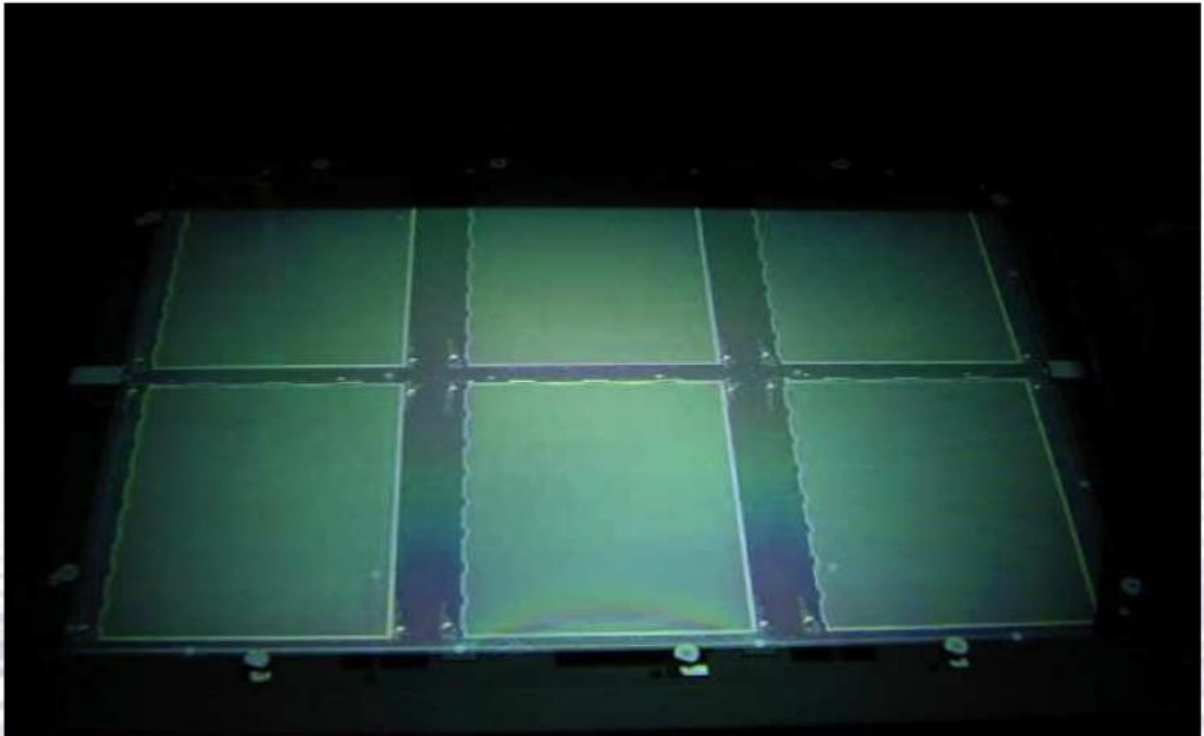

BenQ Confidential (2005/10/28) ©2005, BenQ Corporation

BenQ

LCD背光板构造图

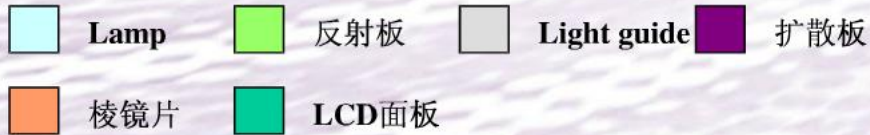
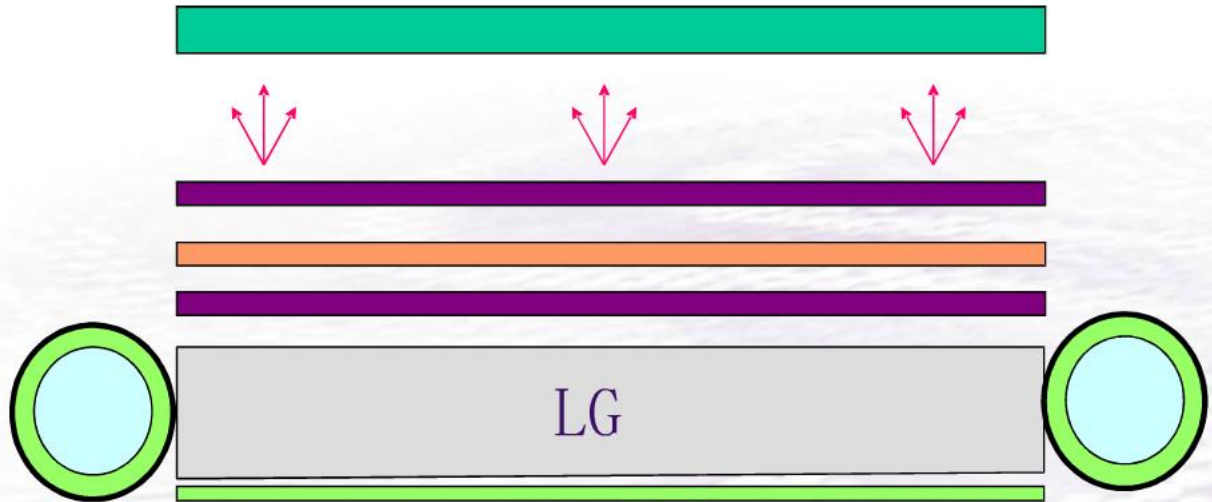

LCD背光板功能

提供具有下列特性的面光源

1. 均匀/足够的亮度
2. 适合的色度 (x, y)

LCD背光板类型

1. 平板式
2. 直下型
3. 楔型

LCD背光板类型

1. 平板式

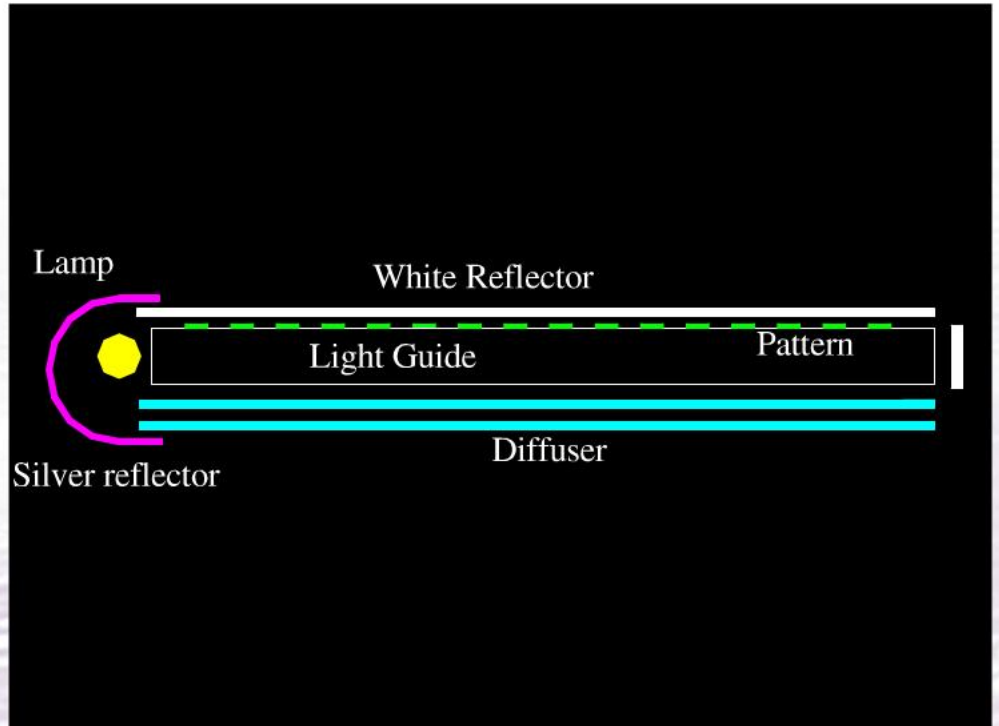
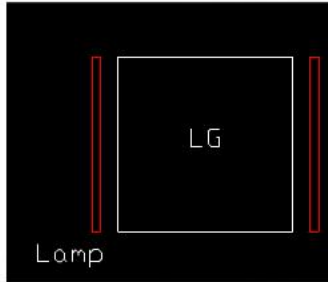

LCD背光板类型

2. 直下型

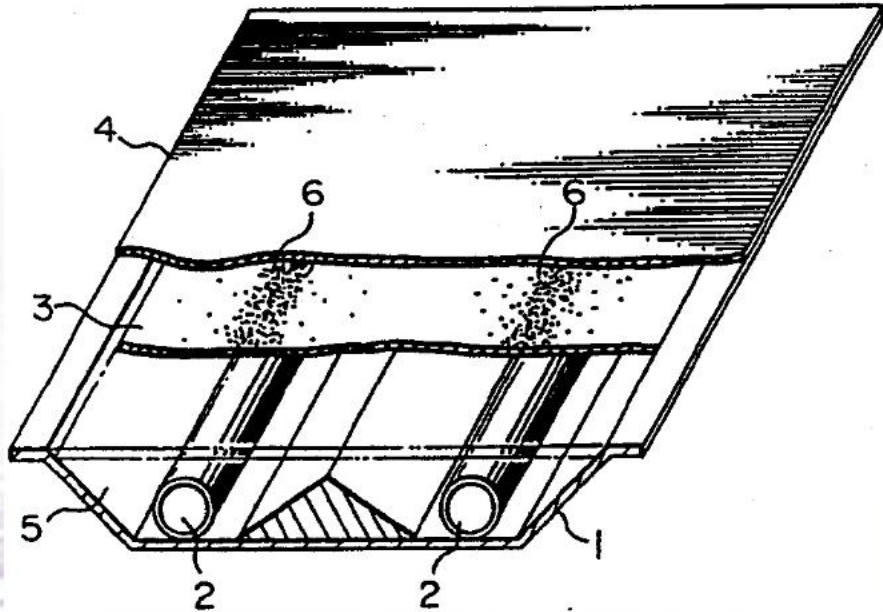

LCD背光板类型

3. 楔型

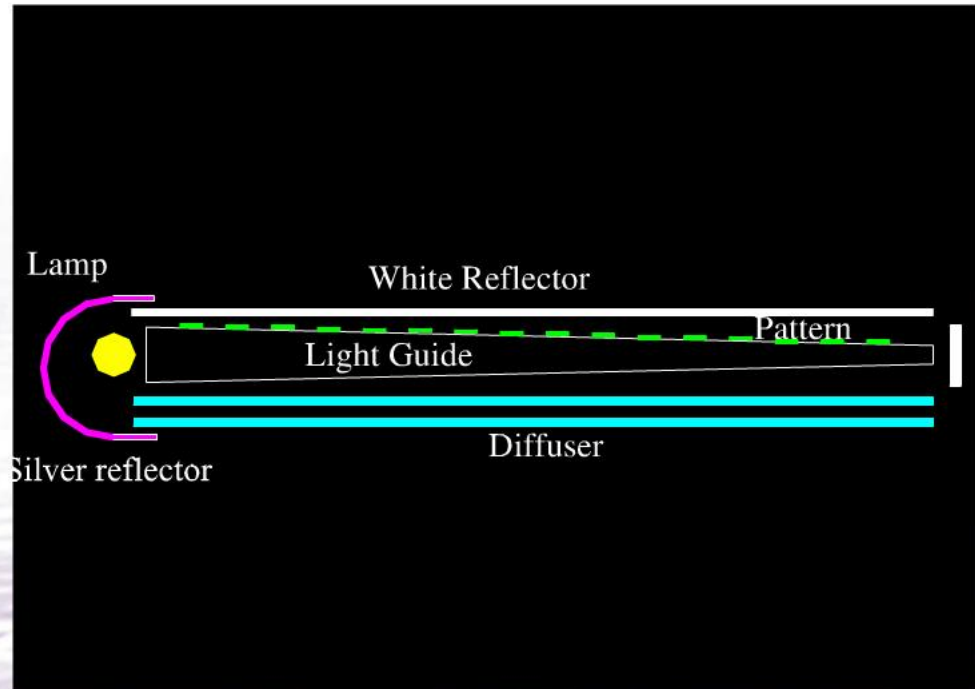



BenQ

Enjoyment Matters